

TECHNICAL NOTE TN-745-AN

Using the Tait
TB8100 in
TaitNet Trunked
Networks

23 May 2006



APPLICABILITY	3
INTRODUCTION	3
TB8100 EQUIPMENT REQUIRED	3
CONNECTING THE TB8100 TO THE CMM/CCM/CM	4
CONFIGURATION OF THE TB8100 BASE STATION	5
<i>CONFIGURING THE CHANNEL TABLE</i>	<i>5</i>
<i>CONFIGURING THE BASE STATION NAME</i>	<i>6</i>
<i>CONFIGURING THE DEFAULT CHANNEL</i>	<i>6</i>
<i>CONFIGURING THE DEFAULT CHANNEL PROFILE</i>	<i>6</i>
<i>CONFIGURING THE SIGNAL PATH</i>	<i>7</i>
<i>CONFIGURING THE DEFAULT SIGNALLING PROFILE</i>	<i>8</i>
<i>CONFIGURING: SYSTEM INTERFACE / FAN CONTROL / MISCELLANEOUS</i>	<i>8</i>
<i>CONFIGURING ALARMS</i>	<i>9</i>
<i>TASK MANAGER SCRIPTS</i>	<i>10</i>
<i>CONFIGURING TASK MANAGER</i>	<i>12</i>
<i>MPT1327 STANDARD SITE ALARMS</i>	<i>14</i>
<i>MPT1327 ENHANCED SITE7 ALARMS</i>	<i>16</i>
SUGGESTED POSITION AND LAYOUT OF EQUIPMENT	18
SIGNAL PATHS (CCM/CMM/CM).....	19
T1511 CCM ALIGNMENT	20
T1711 CMM ALIGNMENT.....	22
T1810 CM ALIGNMENT	24
ISSUING AUTHORITY	25

Applicability

T1511 Control Channel Module (**CCM**)
 T1711 Channel Management Module (**CMM**)
 T1810 Channel Module (**CM**)
 TB8100 Base station fitted with a TaitNet SIF (TBA-SP-S0T1)
 TB8100 Base station fitted with a TaitNet RS232 SIF (TBA-SP-S0L0)
 TB8100 Base Station fitted with a TaitNet Ethernet SIF (TBA-SP-S0K0)
 TB8100 Service Kit (**SK**) Application Version 2.05 or later (V3.0 or later for TaitNet Ethernet SIF)
 TB8100 Firmware (**FW**) Version 2.05 or later (V3.0 or later reciter firmware for TaitNet Ethernet SIF)

If the TaitNet Ethernet SIF is going to be fitted to an existing reciter, please ensure it is hardware revision 00.02 or above, has control board IPN 220-02024-15 or above and is running V3.0 or later firmware.

Note that firmware in other modules may have to be upgraded to be compatible with V3.0 or later reciter firmware. Refer to the current software release note for details.

Introduction

The TB8100 base station is suitable for use as a RF channel in MPT 1327 Trunked networks with Tait infrastructure.

This application note aims to explain what you specifically need to do to use the TB8100 base station in a trunking system. It covers ordering the correct TB8100 SIF, making the necessary hardware connections and configuring the TB8100 Base Station using the Service Kit application.

For further information, please refer to:

- The Service Kit User's Manual or the online Help.
- TB8100 Installation and Operation Manual.
- TN-742 - Remotely Monitoring and Configuring the TB8100 Base Station.
- TN-906 - Connecting to TB8100 Base Stations via an Asynchronous Port Switch.
- TN-931 - TB8100 TaitNet RS232 SIF.
- TN-1142-AN - Connecting to a TB8100 via Ethernet.
- TN-1154-AN-Task Manager Programming Guide.

TB8100 Equipment Required

If you intend to use the TB8100 base station in a trunking system, make sure that you specify these options when you order the TB8100:

- Reciter with a TaitNet, TaitNet RS232 or TaitNet Ethernet SIF.
 Connecting to multiple base stations from the Service Kit can be achieved with the TaitNet RS232 SIF and an Asynchronous Port Switch (APS) via a serial link or with the TaitNet Ethernet SIF with a TCP/IP link.
 Refer to the relevant documents listed in the introduction for further information.
- PMU with internal 13.8V DC 40 Watt auxiliary power supply. This is used to supply power to the T1511 CCM, T1711 CMM & T1810 CM via the reciter's 15-pin system interface connector. *(For 12V PA solutions contact Technical Support)*

TaitNet TB8000 templates are available for the TB8000 Service Kit. These are available from the Technical Support website - <http://support.taitworld.com>

These contain all the configurations outlined in this document. To save configuration time, these can be loaded into the base station by selecting File>New.. in the TB8000 Service Kit.

All that is required then are your custom frequencies, balanced and unbalanced line levels (*if required*), and alarm selection within the task manager. The selection and configuration of these items are also covered in this document.

Connecting the TB8100 to the CMM/CCM/CM

You need to connect the equipment as follows -

1. Route the auxiliary power supply to the reciter's rear DC connector.
2. Using the extension cable supplied with the CMM/CCM*/CM, connect the D-range 15-pin system interface connector to the D-range 15-pin socket on the channel controller.

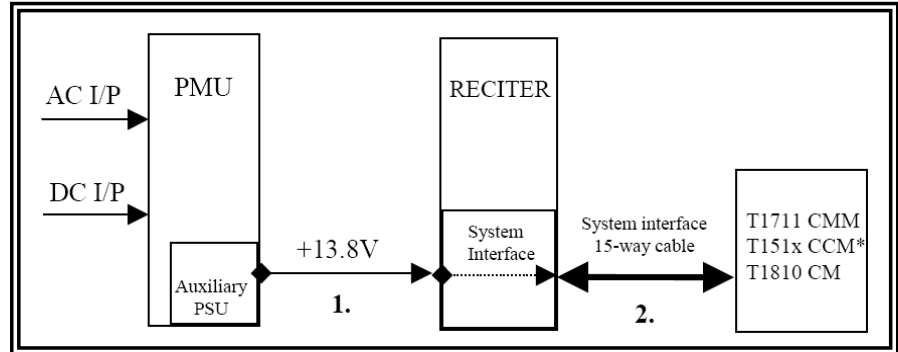

*** T1511 CCM Requires an additional T800 5U Rack fitted with a TA2546 interface PCB (T1511 CCM to TB8100 interface).**

Configuration of the TB8100 Base Station

Configuring the Channel Table

Service Kit Menu Item (SK): Configure>Base Station>Channel Table

Num	Channel Name	Receive Frequency	Transmit Frequency	Signalling Profile	Receive Signalling	Transmit Signalling	Channel Profile
001	Channel 001	406.012500	414.0125	Default	None	None	Default

Delete all previous information.

Enter Channel 001

Enter Receiver Base Frequency (or actual RF channel frequency if entire channel block not being entered)

Enter Transmitter Base Frequency (or actual RF channel frequency if entire channel block not being entered)

Num	Channel Name	Transmit Signalling	Channel Profile	Filter	Power (W)	Channel Spacing
001	Channel 001	None	Default	Pre/De-Emph Speech Ba	50	12.5

Enter Channel Profile as: Default

Enter Pre/De-Emph Filter Type: Speech Band

Enter Desired Transmitter RF power

Enter Channel Spacing



For users wishing to enter an entire channel block into the Reciter select 'Block Copy'

Block Copy	
Channel block start:	2
Channel block end:	255
Receive frequency increment:	12.5 kHz
Transmit frequency increment:	12.5 kHz

Set Channel block start to '2', and the Channel block end to a desired value less than or equal to '255'.

Enter Receiver frequency increment value. (Narrow Band = 12.5kHz, Wide Band = 25kHz)

Enter Transmitter frequency increment value. (Narrow Band = 12.5kHz, Wide Band = 25kHz)

Configuring the Base Station Name

SK: Configure>Base Station>General

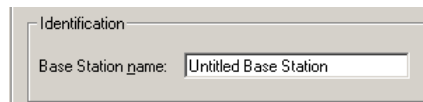

Identification

Base Station name:

This names the base station and is used when logging on with the TB8100 Service Kit.

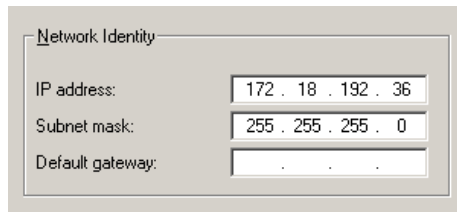

Network Identity

IP address:

Subnet mask:

Default gateway:

This sets the IP address for the Ethernet SIF. For more information, refer to TN-1142-AN "Connecting to a TB8100 via Ethernet" or the on line Help.

Configuring the Default Channel

SK: Configure>Base Station>General

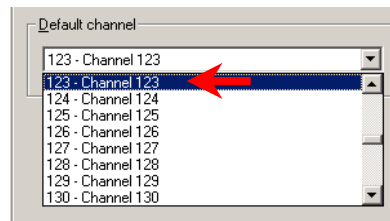

Default channel

123 - Channel 123

123 - Channel 123

124 - Channel 124

125 - Channel 125

126 - Channel 126

127 - Channel 127

128 - Channel 128

129 - Channel 129

130 - Channel 130

Select Default Channel number. (Channel 1 if single channel is used)

Configuring the Default Channel Profile

SK: Configure>Base Station>Channel Profile> Default>General

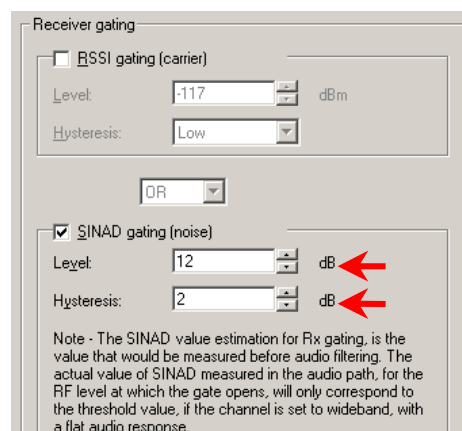

Receiver gating

RSSI gating (carrier)

Level: dBm

Hysteresis:

OR

SINAD gating (noise)

Level: dB

Hysteresis: dB

Note - The SINAD value estimation for Rx gating, is the value that would be measured before audio filtering. The actual value of SINAD measured in the audio path, for the RF level at which the gate opens, will only correspond to the threshold value, if the channel is set to wideband, with a flat audio response.

Recommended Sinad Gating: 12dB Level and 2 dB Hysteresis are suitable for (FW) version 2.05 or later. RSSI Gating is not recommended.

Configuring the Signal Path

SK: Configure>Base Station>Channel Profile> Default>Signal Path

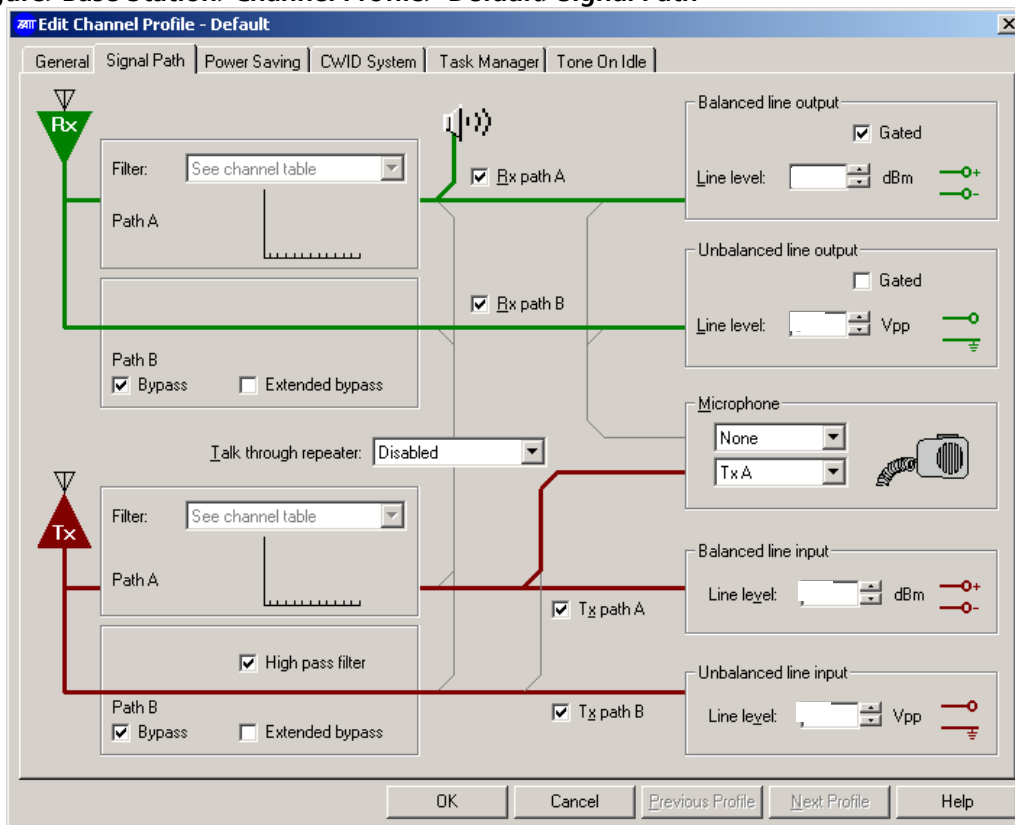

Direct Signal Path Overview

So that the FFSK data has a minimum time delay through the TB8100 base station, the receiver and transmit path B filters are disabled.

This enables a direct output from the receiver to the unbalanced audio output, and direct modulation to the transmitter via the unbalanced inputs.

The Rx and Tx path A filters remain unchanged: a normal voice band de-emphasised received signal will be passed to the balanced line outputs of the Reciter and then to the CMM/CCM/CM.

Conversely, transmit audio from the CMM/CCM/CM will be passed to the Reciter via the balanced line inputs. This will be pre-emphasised by the reciter and then broadcast over the air.

Receiver Path

Enable: Path B Bypass

Disable: Unbalanced Gated Output.

Do **NOT** enable Extended Bypass (V2.09 and later Service Kit and reciter firmware).

Transmitter Path

Enable: Path B Bypass *and* High Pass Filter only.

Do **NOT** enable Extended Bypass (V2.09 and later Service Kit and reciter firmware).

Note:

The balanced line input and output has a nominal value of '-10dBm', however this can vary between '-9.5dBm' and '-11.5dBm' depending on the Reciter frequency band, bandwidth selected, and the Trunking Channel Control equipment used.

This is covered later in this document along with the unbalanced input and output levels in the alignment procedure for the individual CMM/CCM/CM modules.

The templates supplied are pre-configured with nominal values of '-10dBm' input and output levels for the balanced line interfaces, and '1 Vpp' for the unbalanced line interfaces.

Configuring the Default Signalling Profile

SK: Configure>Base Station>Signalling Profile> Default>General

The screenshot shows the 'General' configuration page for a signalling profile. It contains several sections:

- Transmit lockout:** Transmit timer: 3 min; Lockout duration: 1 sec.
- Anti-Kerchunking:** Transmissions less than: 500 ms. Radio buttons for 'Will not key transmitter' and 'Will not enable tail timers' are present.
- Hang time:** Duration: 100 ms.
- Reverse tone burst:** Duration: 100 ms; Phase angle: -120 degrees.
- Soft-off time:** Checked checkbox; Duration: 500 ms (indicated by a red arrow).

Set Soft-off timer to the suggested **500ms**

The purpose of this timer in a trunking system is to allow radios completing a call to return to the control channel before the traffic channel carrier is dropped at the call closure.

Configuring: System Interface / Fan Control / Miscellaneous

SK: Configure>Base station>System Interface>Channel Selection

The screenshot shows the 'Channel Selection' configuration page. It includes:

- Channel selection:** Unchecked checkbox (indicated by a red arrow).
- Pins to use:** 1 bit selection.
- Format options:** Binary format, BCD format (selected), and Invert.
- Number of selectable channels:** 1.

Disable Channel Selection

SK: Configure>Base station>Fan Control>PA Fan Control

The screenshot shows the 'PA fan control' configuration page. It includes:

- Threshold temperature:** 50 °C (indicated by a red arrow).
- Only run fan when transmitting:** Unchecked checkbox.

Set PA Fan Control to a suitable Threshold (Recommended 50°C)

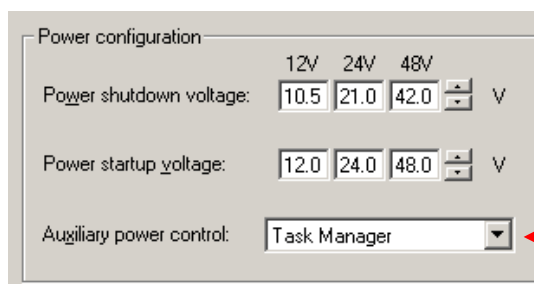
SK: Configure>Base station>Miscellaneous>Power Configuration

Set the Auxiliary power control to Task Manager. This allows the Reciter to control the active state of the CMM/CCM/CM. The Task Manager operating in the Reciter turns on the auxiliary power supply once a pre-determined timer as expired to allow all reciters to complete their power up sequences.

This prevents the CMM/CCM modules from powering up before the TB8100 base station channel is ready for service, otherwise the CMM/CCM will shut down the channel due to RF power alarms, and move to the next channel.

The Task Manager also provides a reset delay (switch off) to the Auxiliary power supply when entering Run Mode from a Standby state.

This also adds the ability to remotely reset the CMM/CCM modules from a U3 (Major) Alarm state.

With V3.0 or later reciter firmware, the CMM/CCM/CM can also be powered off when the base station is set to Standby.

Note: The second Reciter in a Dual Rack is unable to control the PMU and cannot Enable or Disable the Auxiliary Power supply hence the requirement for the power up delay. If the option to disable the auxiliary power supply in standby mode (V3.0 firmware and later only) has been enabled in task manager, remember that the CMM/CCM/CM connected to the second reciter will be switched off if the first reciter is put into standby mode. If the second reciter is put into standby mode, the CMM/CCM/CM is not switched off.

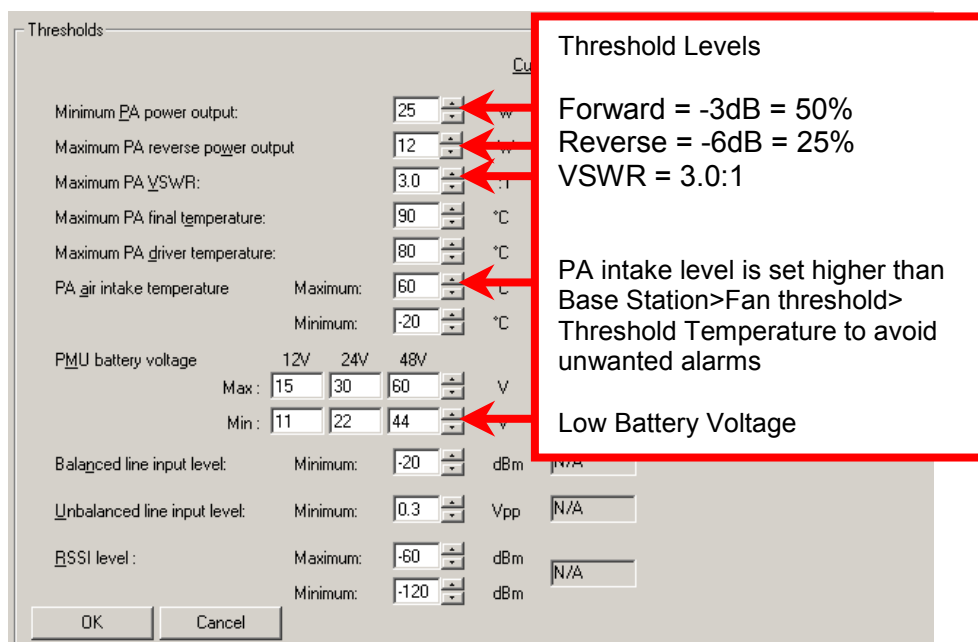
Configuring Alarms**SK: Configure>Alarms>Thresholds**

Enter Low Forward Power level: -3dB of Transmitter setting = 50% (1/2) i.e. 25W for 50W, 50W for 100W.
Enter High Reverse Power level: -6dB of Transmitter setting = 25% (1/4) i.e. 12W for 50W, 25W for 100W.

SK: Configure>Alarms>Alarm Control

The screenshot shows the 'Alarm Control' configuration window. It is organized into four main sections:

- Reciter:**
 - Power up failure (checked)
 - Channel invalid (checked)
 - Synthesiser out of lock:
 - Exciter (checked)
 - Digital (checked)
 - Receiver (checked)
- System:**
 - Balanced input low (unchecked)
 - Unbalanced input low (unchecked)
 - External reference:
 - Absent (unchecked)
 - Invalid (unchecked)
 - RSSI:
 - High (unchecked)
 - Low (unchecked)
 - Air intake temperature:
 - High (checked)
 - Low (checked)
- Power Amplifier:**
 - No PA detected (checked) ← Red arrow
 - Fan failure (checked) ← Red arrow
 - Shutdown (checked)
 - VSWR high (checked) ← Red arrow
 - Current:
 - Driver high (checked)
 - Final 1 (checked)
 - Final 2 (checked)
 - Imbalance (checked)
 - Supply voltage:
 - High (checked)
 - Low (checked)
 - Temperature high:
 - Driver (checked)
 - Final 1 (checked)
 - Final 2 (checked)
- Power Management Unit:**
 - No PMU detected (checked) ← Red arrow
 - Fan failure (checked) ← Red arrow
 - Shutdown imminent (checked)
 - Battery:
 - Voltage high (checked)
 - Voltage low (checked)
 - Protection mode (checked)
 - Output:
 - Voltage high (checked)
 - Voltage low (checked)
 - Current high (checked)
 - Mains supply failed (checked)
 - Power up fault (checked)
 - Temperature high (checked)

Buttons for 'OK' and 'Cancel' are located at the bottom left of the window.

Uncheck/Disable Alarm controls as follows in Dual Reciter Rack Configurations:

- Disable Fan Failure alarms in the PA and PMU sections, in both Reciters.
- In Reciter 2, disable the No PMU detected alarm.

Task Manager Scripts**SK: Configure>Base Station>Task Manager**

The TaitNet TB8000 templates available via the support website have the all the required task manager scripts entered.

There are two main areas. The first falls into the General category.

This section is where the delayed Auxiliary startup is configured. It also controls the auxiliary supply so a CMM/CCM/CM reset occurs when a transition is made from standby to run mode. Associated with this is the ability to switch off the Auxiliary supply when the base station is put into standby mode.

The second area controls the alarm outputs of the Base Station. There are two configurations provided.

Which of these is to be used is dependent on the site software and equipment you are using. This is covered on the following page.

Task Manager Items**General**

- Aux Supply Initialise.
 - IF Base station in run mode THEN Aux Reset
 - IF Timer Expired (Reset Aux Supply) THEN TB8100 Initialised
- V3.0 or Later Reciter Firmware
- Switch off CMM on Stby
 - IF NOT Base station in run mode THEN Disable auxiliary supply

When the Base Station enters Run Mode it will perform the custom action Aux Reset.

When the Timer "Reset Aux Supply" expires it will then perform the custom action TB8100 Initialised.

This allows remote resetting of the CMM/CCM equipment by making a stand-by mode to run mode transition on the base station.

From V3.0 of reciter firmware, it is now possible to switch the auxiliary power supply off when the base station is put into Standby mode.

The line " IF NOT Base station in run mode THEN Disable auxiliary supply" switches the auxiliary power supply off in standby mode. This line has no affect if the reciter is running earlier firmware.

Alarms

Enable only **one** option below, determined by your system hardware. Disable the alarm profile you are not using.

Note: For T1810 CM's, alarms are not supported therefore both standard 'MPT1327 Alarms' **and** 'MPT1327 Enhance Site7 Alarms' would be disabled

Standard MTP1327 Alarms Summary

Standard Alarms

IF Low Fwd Pwr THEN Low Fwd Pwr Set
 IF NOT Low Fwd Pwr THEN Low Fwd Pwr Clear
 IF High Rev Pwr THEN High Rev Pwr Set
 IF NOT High Rev Pwr THEN High Rev Pwr Clear

When the base station is operating normally it activates digital outputs 1 and 2, causing the open collectors to close. (The CMM requires inverted logic.) When the Ethernet SIF is used, digital outputs 2 and 3 are used. When the base station detects a low forward power or high reverse alarm it will deactivate the respective digital output, causing the output to float high and this generates an alarm in the CMM/CCM.

Enhanced Site7 system Alarm Summary (CMM/CCM MIN 7.05 and SMX V7.08 or later)

Enhanced Alarms

IF Major Alarms THEN Major Actions Set
 IF NOT Major Alarms THEN Major Actions Clear
 IF Minor Alarms THEN Minor Actions Set
 IF NOT Minor Alarms THEN Minor Actions Clear

When the Base station is operating the Clear actions will be performed. If a Major or Minor alarm occurs, the base station will perform the associated Custom Action. When the alarm clears, the associated Clear Custom Action is performed

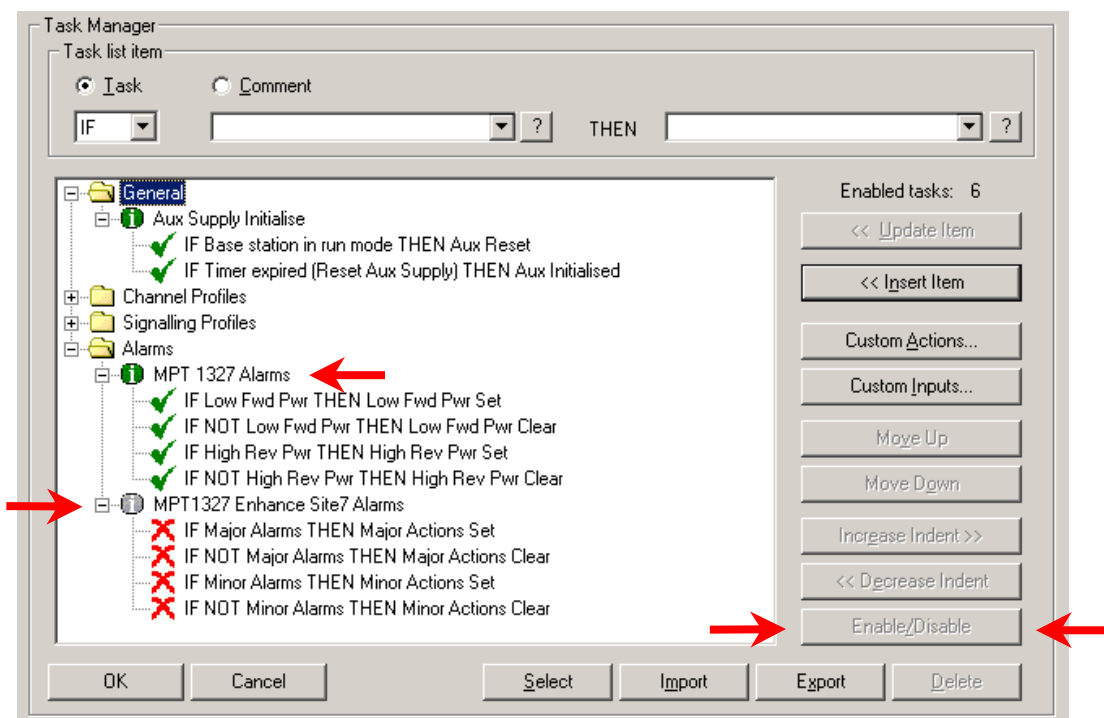

Configuring Task Manager

The following section describes how the 'Task Manager' is configured in the sample TaitNet templates. This is information provided for reference, custom applications, or if the templates are not available.

SK: Configure>Task Manager>Flags

Flags	
	Name
1:	TB8100 Active
2:	Major Alarms
3:	Minor Alarms
4:	Low Fwd Pwr
5:	High Rev Pwr
6:	..
7:	..
8:	..

Flags

Set the Flags table as above.

TB8100 Active: used to indicate that the TB8100 is active and the Auxiliary supply is also on.

Major Alarms: used with an Enhanced Site7 MPT1327 System to indicate major alarm states. (*Enhanced = CMM/CCM containing MIN 7.05 and SMX V7.08 or later, this flag is not required for earlier versions of site software*)

Minor Alarms: used with an Enhanced Site7 MPT1327 System to indicate minor alarm states. (*Enhanced = CMM/CCM containing MIN 7.05 and SMX V7.08 or later, this flag is not required for earlier versions of site software*)

Low Fwd Pwr: used with standard site alarms to indicate the PA has reported a low forward power alarm.

High Rev Pwr: used with standard site alarms to indicate the PA has reported a high VSWR alarm.

SK: Configure>Task Manager>Timers

Timers			
	Name	Maximum	Units
1:	Reset Aux Supply	5	Seconds
2:	T2	0	Days
3:	T3	0	Days
4:	T4	0	Days
5:	T5	0	Days
6:	T6	0	Days
7:	T7	0	Days
8:	T8	0	Days

Timers

There is one timer to enter as shown above for all site software versions.

Reset Aux Supply = 5 Seconds (*2 seconds is a minimum suggested delay period however 5 seconds is provided in the templates for additional reliability.*)

This has been added to allow other reciters in the site to become active before the powering up of the CMM/CCM/CM modules begins.

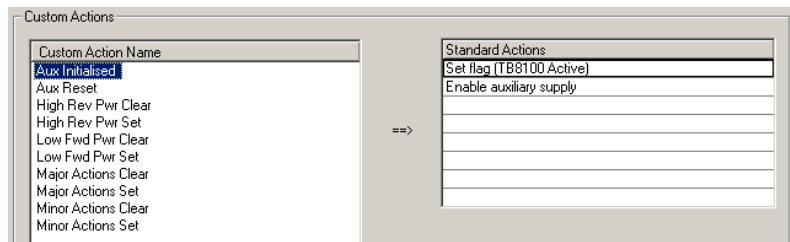
SK: Configure>Task Manager>Custom Actions**Custom Action - Aux Initialised**

Enter the following Custom Action Name – ‘Aux Initialised’. The ‘Standard Actions’ for this Action name are – ‘Set Flag (TB8100 Active)’, and ‘Enable auxiliary Supply’.

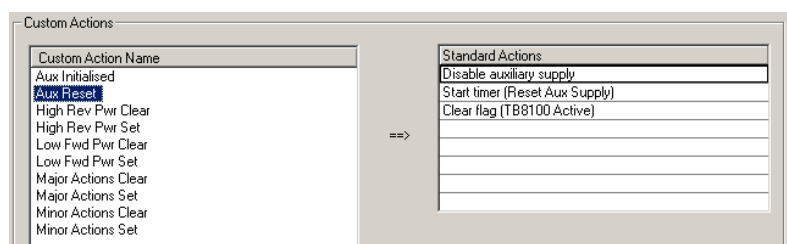
**Custom Action - Aux Reset**

Enter the following Custom Action Name – ‘Aux Reset’. The ‘Standard Actions’ for this Action name are – ‘Disable auxiliary Supply’, ‘Start timer (Reset Aux Supply)’, and ‘Clear flag (TB8100 Active)’.

The Custom actions described on the following pages relate to the two types of site alarms available.

MPT1327 Standard Site Alarms

The following custom actions can be used with all Site software versions CMM/CCM MIN V7.04 or SMX V7.07 or earlier.

If in doubt contact technical support for further advice.

SK: Configure>Task Manager>Custom Actions

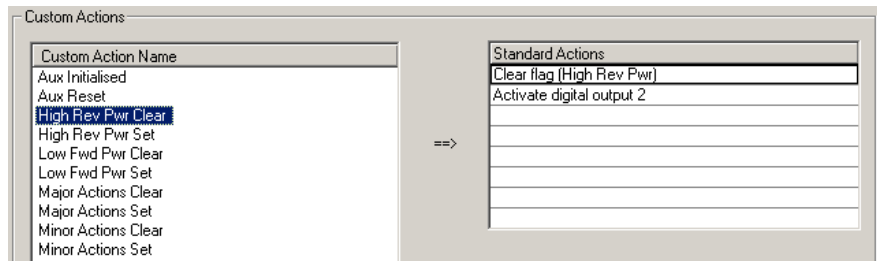

Custom Action – High Rev Pwr Clear

Enter the following Custom Action Name – ‘High Rev Pwr Clear’. The ‘Standard Actions’ for this Action name are – ‘Clear Flag (High Rev Pwr)’, and ‘Activate digital output 2’. **Note:** If the TaitNet Ethernet SIF is used, the Standard Action will be ‘Activate digital output 3’

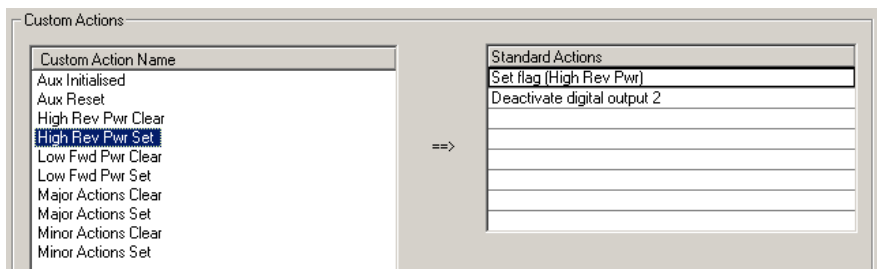

Custom Action – High Rev Pwr Set

Enter the following Custom Action Name – ‘High Rev Pwr Set’. The ‘Standard Actions’ for this Action name are – ‘Set Flag (High Rev Pwr)’, and ‘Deactivate digital output 2’. **Note:** If the TaitNet ethernet SIF is used, the Standard Action will be ‘Activate digital output 3’

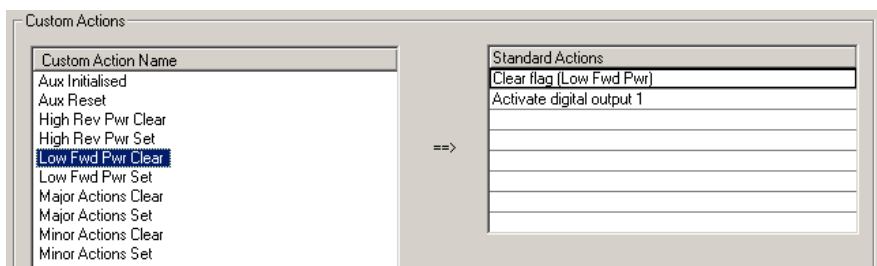

Custom Action – Low Fwd Pwr Clear

Enter the following Custom Action Name – ‘Low Fwd Pwr Clear’. The ‘Standard Actions’ for this Action name are – ‘Clear Flag (Low Fwd Pwr)’, and ‘Activate digital output 1’. **Note:** If the TaitNet Ethernet SIF is used, the Standard Action will be ‘Activate digital output 2’

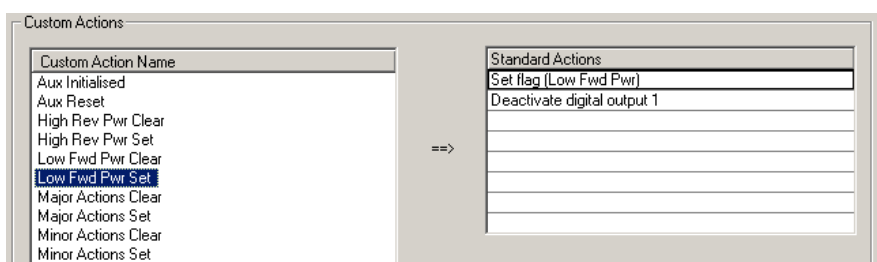

Custom Action – Low Fwd Pwr Set

Enter the following Custom Action Name – ‘Low Fwd Pwr Set’. The ‘Standard Actions’ for this Action name are – ‘Set Flag (Low Fwd Pwr)’, and ‘Deactivate digital output 1’. **Note:** If the TaitNet Ethernet SIF is used, the Standard Action will be ‘Activate digital output 2’

SK: Configure>Task Manager>Custom Inputs

The screenshot shows the 'Custom Inputs' configuration window. On the left, a list of custom input names includes 'High Rev Pwr', 'Low Fwd Pwr', 'Major Alarms', and 'Minor Alarms'. On the right, the 'Logic' section is configured with two inputs: 'VSWR fault' and 'PA carrier present'. Both inputs are preceded by a checkbox and are connected to an 'AND' logic gate.

Custom Input – High Rev Pwr

Enter the following Custom Input Name – ‘High Rev Pwr’. The ‘Input Logic’ for this Custom Input Name are – ‘VSWR fault’ **AND** ‘PA carrier present’.

The screenshot shows the 'Custom Inputs' configuration window. On the left, the list of custom input names includes 'High Rev Pwr', 'Low Fwd Pwr', 'Major Alarms', and 'Minor Alarms'. On the right, the 'Logic' section is configured with two inputs: 'Forward power low' and 'PA carrier present'. Both inputs are preceded by a checkbox and are connected to an 'AND' logic gate.

Custom Input – Low Fwd Pwr

Enter the following Custom Input Name – ‘Low Fwd Pwr’. The ‘Input Logic’ for this Custom Input Name are – ‘Forward power low’ **AND** ‘PA carrier present’.

MPT1327 Enhanced Site7 Alarms

The following custom actions are only to be used with Site 7 Systems containing CMM/CCM MIN V7.05 or later. If in doubt contact technical support for further advice.

SK: Configure>Task Manager>Custom Actions

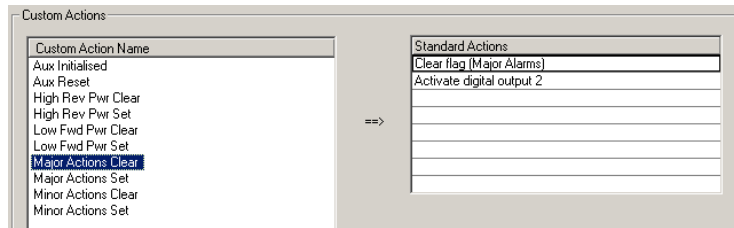

Custom Action - Major Alarms Clear

Enter the following Custom Action Name – 'Major Alarms Clear'. The 'Standard Actions' for this Action name are – 'Clear Flag (Major Alarms)', and 'Activate digital output 2'. **Note:** If the TaitNet Ethernet SIF is used, the Standard Action will be 'Activate digital output 3'

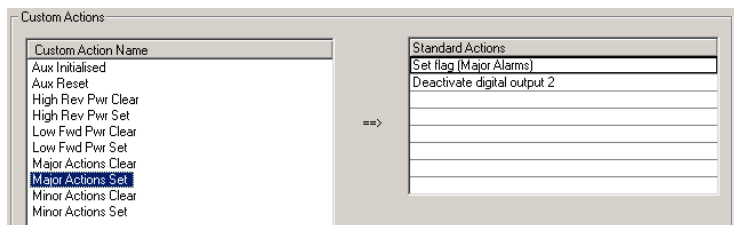

Custom Action - Major Alarms Set

Enter the following Custom Action Name – 'Major Alarms Set'. The 'Standard Actions' for this Action name are – 'Set Flag (Major Alarms)', and 'Deactivate digital output 2'. **Note:** If the TaitNet Ethernet SIF is used, the Standard Action will be 'Activate digital output 3'

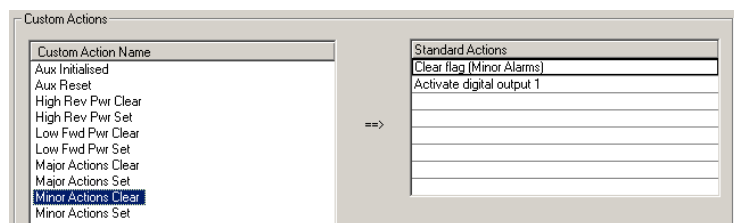

Custom Action - Minor Alarms Clear

Enter the following Custom Action Name – 'Minor Alarms Clear'. The 'Standard Actions' for this Action name are – 'Clear Flag (Minor Alarms)', and 'Activate digital output 1'. **Note:** If the TaitNet Ethernet SIF is used, the Standard Action will be 'Activate digital output 2'

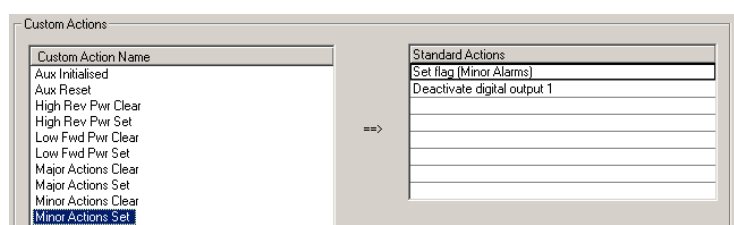

Custom Action - Minor Alarms Set

Enter the following Custom Action Name – 'Minor Alarms Set'. The 'Standard Actions' for this Action name are – 'Set Flag (Minor Alarms)', and 'Deactivate digital output 1'. **Note:** If the TaitNet Ethernet SIF is used, the Standard Action will be 'Activate digital output 2'

SK: Configure>Task Manager>Custom Inputs

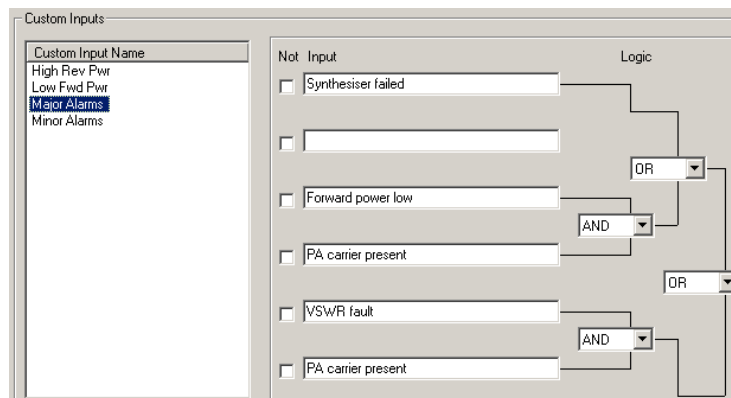

Custom Input - Major Alarms

Enter the following Custom Input Name – ‘Major Alarms’. The ‘Input Logic’ for this Custom Input Name are – ‘Synthesiser failed’ OR ‘VSWR fault’ **AND** ‘PA carrier present’ OR ‘Forward power Low’ **AND** ‘PA carrier present’

This Alarm will withdraw the channel from service even in site fallback mode, and requires urgent attention.

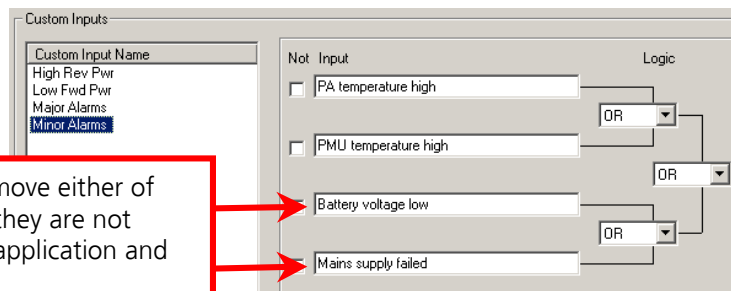

Note – You can remove either of these two items if they are not applicable to your application and PMU selection.

Custom Input - Minor Alarms

Enter the following Custom Input Name – ‘Minor Alarms’. The ‘Input Logic’ for this Custom Input Name are – ‘PA Temperature’ OR ‘PMU temp high’ OR ‘Mains supply failed’ OR ‘Battery voltage low’

This Alarm gives notification that the site needs some attention however it will remain in service.

Suggested Position and Layout of Equipment

During operation, the TB8100 base station can become hot. This is normal since it is designed to operate at high temperatures (>60°Celsius (>+140°F)). The power amplifier (PA) fan turns on when the PA temperature reaches 50°Celsius (122°F), this is adjustable via Configure>Base Station>Fan Control

Rack Setups

Dual Channel CMM Bin

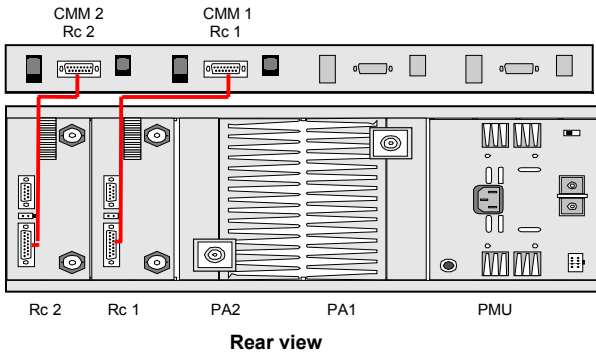

Quad Channel CMM Bin

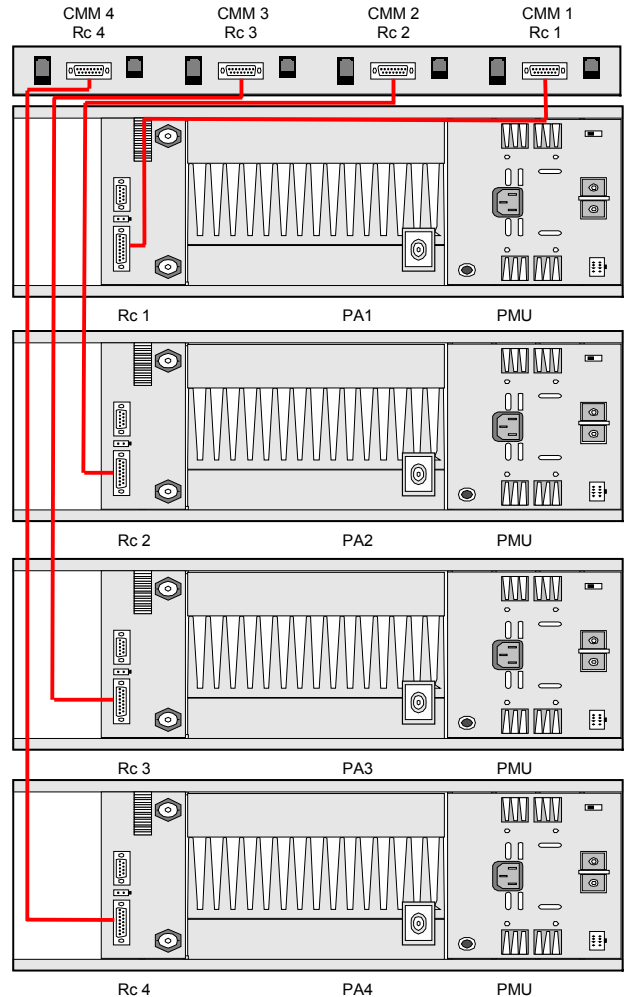

Quad Channel CMM Bin

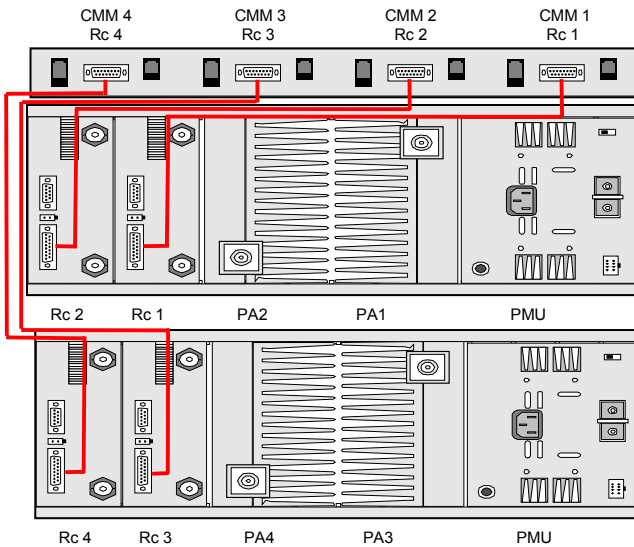

Signal Paths (CCM/CMM/CM)

T1711 CMM / T151x CCM audio and data paths

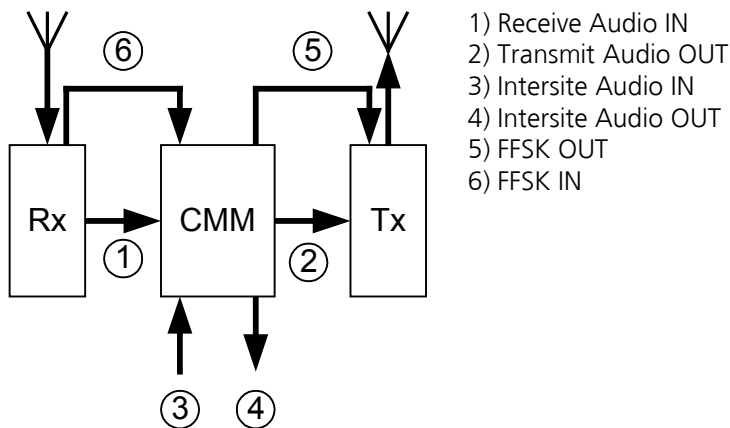

Intersite audio connections

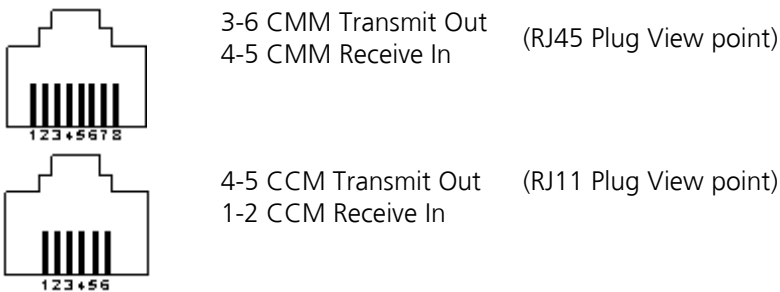

T1810 CM audio and data paths

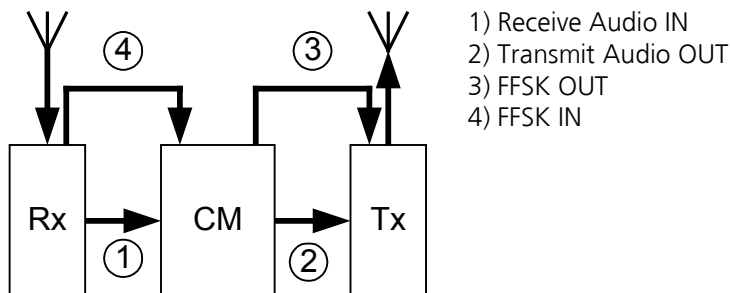

T1511 CCM Alignment

Note – The following set up procedure relies on the base station SIF being correctly calibrated. (refer - TB8100 Calibration Kit Software Manual)

SK: Configure>Base Station>Channel Profile> Default>Signal Path

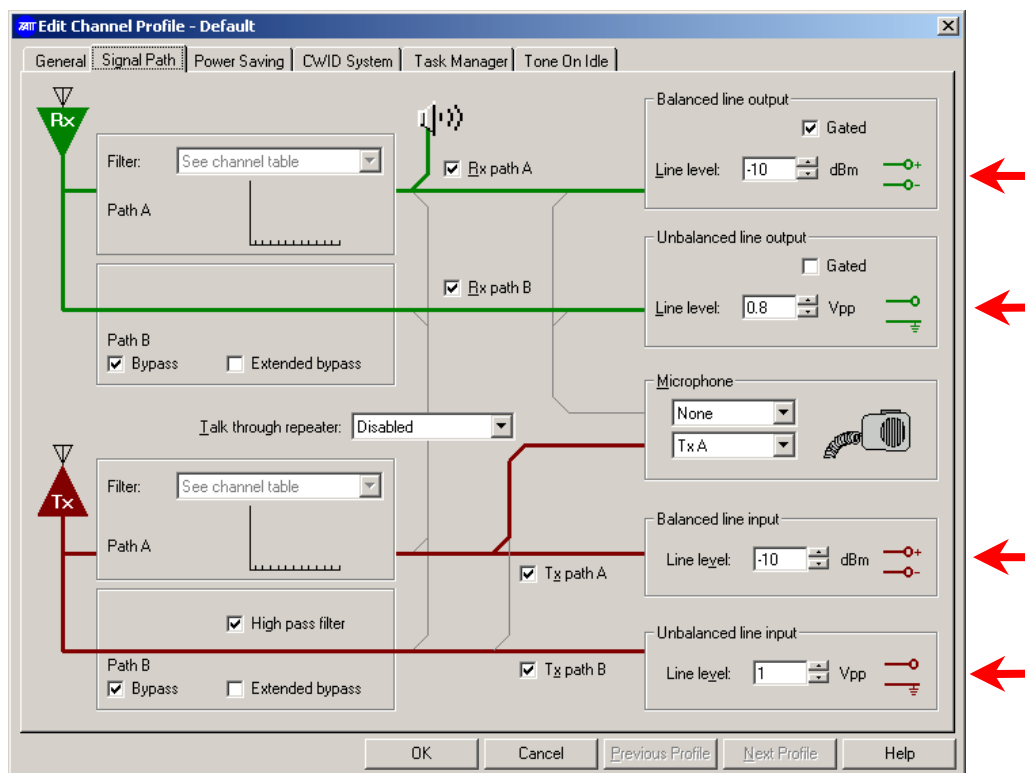

Configure the Signal Path line inputs and outputs to the following levels (shown above) -

- Balanced line output = -10dBm
- Unbalanced line output = 0.8Vpp
- Balanced line input = -10dBm
- Unbalanced line input = 1Vpp

The talk-through audio should be checked as follows

1. Connect a signal generator to the base station receiver, set to the frequency of operation.
2. Attach the output of the PA to modulation meter or similar measuring device. (via suitable attenuator if necessary)
3. Modulate a 1kHz test tone onto the carrier of the signal generator at a deviation equal to 60% of the maximum permissible deviation (1.5kHz for 12.5kHz channel spacing and 3.0kHz for 25kHz channel spacing systems).
4. Set the signal level to represent a fully quieting strong signal (e.g. -80dBm).
5. Set SW101 and SW102 on the T1511 CCM to '90' (Local audio level check mode). Power cycle the card.
6. With the Signal path configured as shown for a T151x CCM the deviation measured should be ~ 60% of system max.
7. Slight adjustment of the TB8100 balanced line input may be required for a more exact 60% of max deviation, however large changes may indicate a SIF calibration issue.

The Rx FFSK input signal should be adjusted as follows

1. The Receive FFSK signal is non-adjustable on a T151x. Because of this, the nominal value to place in the Unbalanced Line output of the Receiver is 0.8Vpp. (Equivalent to Audio 1 output level on T800 equipment)

The TX FFSK output signal should be adjusted as follows

1. Attach the output of the PA to modulation meter or similar measuring device. *(via suitable attenuator if necessary)*
2. With the T151x CCM running as a control channel transmitting FFSK or using Test Mode '96'. Adjust the 'FFSK Adjust' pot until 60% of max system deviation is achieved on the modulation meter.

The Intersite Receive Audio should be adjusted as follows (input from DAS)

1. Set the following links within the T151x. Link 303 **1-2**, Link 304 **2-3**.
2. Connect a 2 wire audio cable from an audio tone generator, or similar, to pins 1 and 2 of the CCM intersite audio RJ11 socket.
3. Attach the output of the PA to modulation meter or similar measuring device. *(via suitable attenuator if necessary)*
4. Apply a 1kHz-test tone of '-10dBm' to the line from the test tone generator.
5. Set SW101 and SW102 on the T1511 CMM to '91' *(Intersite audio level check mode)*. Power cycle the card.
6. Adjust the intersite audio in pot *(I/S RX Adjust)* until 60% of maximum system deviation is achieved.

The Intersite Transmit Audio should be adjusted as follows (output to DAS)

1. Connect a signal generator to the base station receiver, set to the frequency of operation.
2. Modulate a 1kHz test tone onto the carrier of the signal generator.
3. Set the signal level to represent a fully quieting strong signal (e.g. -80dBm).
4. Connect pins 4 and 5 of the CCM intersite audio RJ11 socket to an audio level-measuring device. If this meter does not have a 600-ohm input impedance, a 600ohm load will have to be placed across the balanced audio lines. The equipment may have to then be configured to perform accurate measurements with this load applied. (For example, an Agilent/HP Service Monitor needs to be told there is a 600ohm load applied to the audio input for accurate measurements to occur)
5. Set SW101 and SW102 on the T151x CCM to '91' *(Intersite audio level check mode)*. Power cycle the card.
6. Adjust the intersite audio out pot *(I/S TX Adjust)* to obtain an output level of '-10dBm' from the line.

T1711 CMM Alignment

Note – The following set up procedure relies on the base station SIF being correctly calibrated. (refer - TB8100 Calibration Kit Software Manual)

SK: Configure>Base Station>Channel Profile> Default>Signal Path

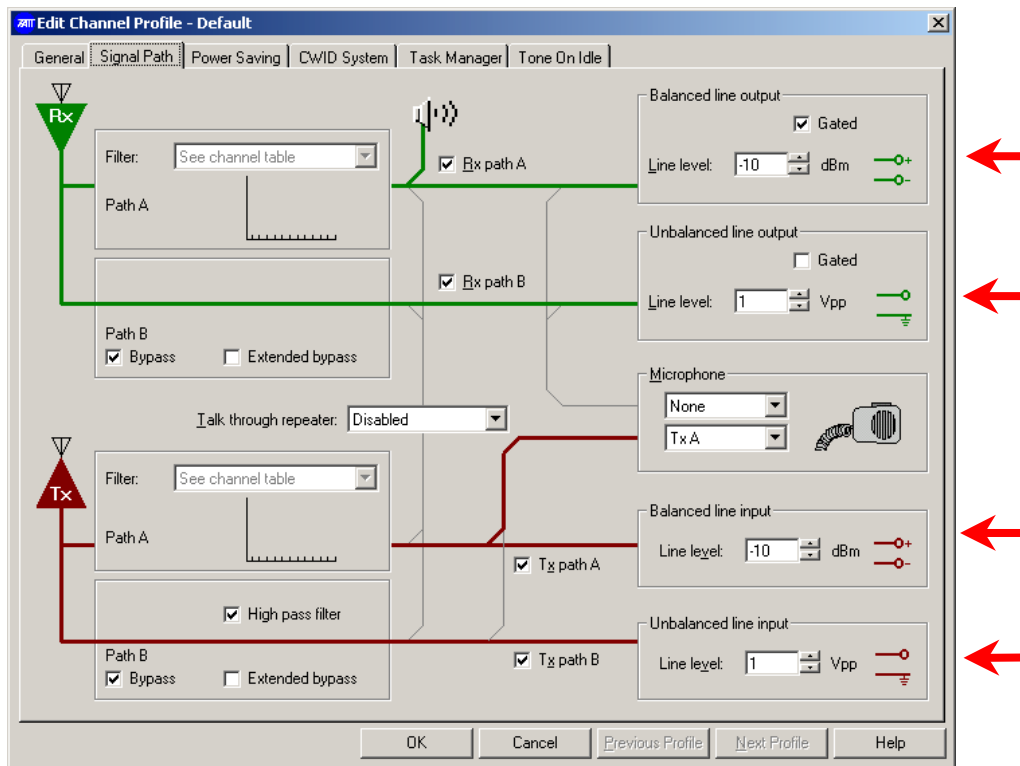

Configure the Signal Path line inputs and outputs to the following levels (*shown above*) -

- Balanced line output = -10dBm
- Unbalanced line output = 1Vpp
- Balanced line input = -10dBm
- Unbalanced line input = 1Vpp

The talk-through audio should be checked as follows

1. Connect a signal generator to the base station receiver, set to the frequency of operation.
2. Attach the output of the PA to modulation meter or similar measuring device. (*via suitable attenuator if necessary*)
3. Modulate a 1kHz test tone onto the carrier of the signal generator at a deviation equal to 60% of the maximum permissible deviation (1.5kHz for 12.5kHz channel spacing and 3.0kHz for 25kHz channel spacing systems).
4. Set the signal level to represent a fully quieting strong signal (e.g. -80dBm).
5. Set SW101 and SW102 on the T1711 CMM to '90' (*Local audio level check mode*). Power cycle the card.
6. With the Signal path configured as shown for a T1711 CMM the deviation measured should be ~ 60% of system max.
7. Slight adjustment of the TB8100 balanced line input may be required for a more exact 60% of max deviation, however large changes may indicate a SIF calibration issue, the values suggested were tested on both old and new revisions of T1711 CMM hardware.

The Rx FFSK input signal should be adjusted as follows

1. Link PL311 (pre-emp) to **1 – 2**, Rx FFSK signal is flat
2. Connect a RF signal generator to the base station receiver, set to the frequency of operation.
3. Set the signal level to represent a fully quieting strong signal (e.g. -80dBm).
4. Modulate the carrier with a 1500Hz tone at a deviation equal to 60% of the maximum permissible deviation (1.5kHz for 12.5kHz channel spacing and 3.0kHz for 25kHz channel spacing systems).
5. If the CMM is operating as a control channel, fail the channel by making a switch transition on dipswitch eight from 'on' to 'off'. (SW300)
6. Now adjust the 'FFSKIN' pot to obtain a 234mVrms (0.66V peak-to-peak) signal at P305

The Tx FFSK output signal should be adjusted as follows

1. Set PL301 (De-emp) to **1 – 2**, Tx FFSK signal is flat
2. Attach the output of the PA to modulation meter or similar measuring device. (*via suitable attenuator if necessary*)
3. With the T1711 card running as a control channel transmitting FFSK or using test mode '**96**'. Adjust the 'FFSKOUT' pot until 60% of max system deviation is achieved on the modulation meter.

The Intersite receive audio should be adjusted as follows (input from DAS)

1. Connect a 2 wire audio cable from an audio tone generator or similar to pins 4 and 5 of the CMM intersite audio RJ45 socket.
2. Attach the output of the PA to modulation meter or similar measuring device.
3. Apply a 1kHz-test tone of '-10dBm' to the line from the test tone generator.
4. Set SW101 and SW102 on the T1711 CMM to '**91**' (*Intersite audio level check mode*). Power cycle the card.
5. Adjust the intersite in pot (ISIN) until 60% of maximum system deviation is achieved.

The Intersite transmit audio should be adjusted as follows (output to DAS)

1. Connect a signal generator to the base station receiver, set to the frequency of operation.
2. Modulate a 1kHz test tone onto the carrier of the signal generator.
3. Set the signal level to represent a fully quieting strong signal (e.g. -80dBm).
4. Connect pins 3 and 6 of the CMM intersite audio RJ45 socket to an audio level-measuring device. If this meter does not have a 600-ohm input impedance, a 600ohm load will have to be placed across the balanced audio lines. The equipment may have to then be configured to perform accurate measurements with this load applied. (For example, an Agilent/HP Service Monitor needs to be told there is a 600ohm load applied to the audio input for accurate measurements to occur)
5. Set SW101 and SW102 on the T1711 CMM to '**91**' (*Intersite audio level check mode*). Power cycle the card.
6. Adjust the intersite out pot (ISOUT) to obtain an output level of '-10dBm' from the line.

T1810 CM Alignment

Note – The following set up procedure relies on the base station SIF being correctly calibrated. (refer - TB8100 Calibration Kit Software Manual)

SK: Configure>Base Station>Channel Profile> Default>Signal Path

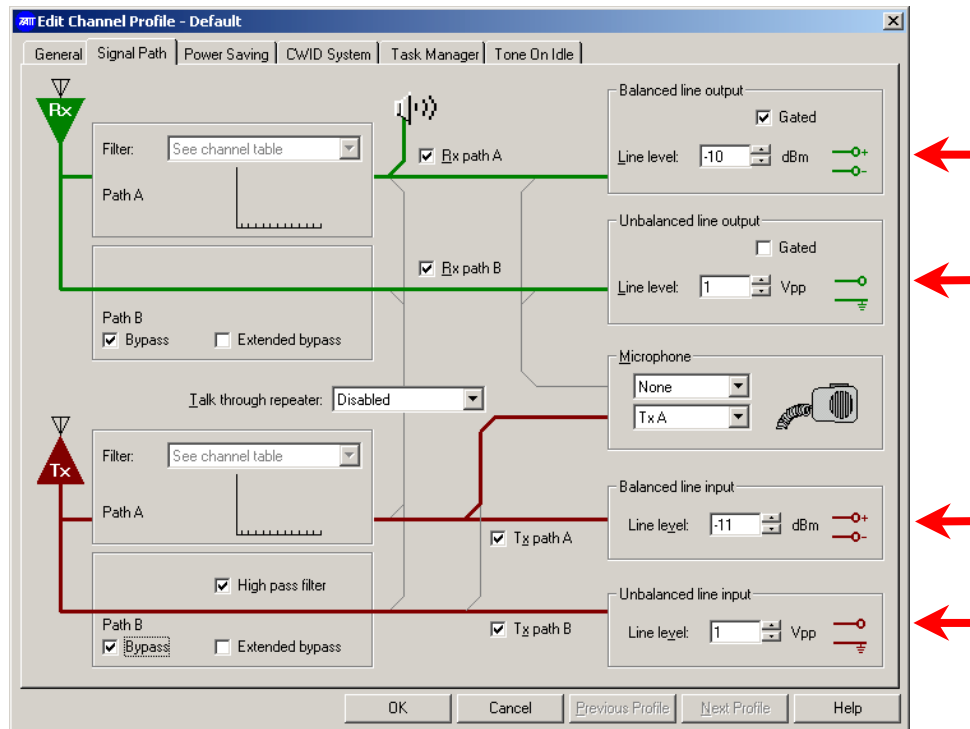

Configure the Signal Path line inputs and outputs to the following levels (*shown above*) -

- Balanced line output = -10dBm
- Unbalanced line output = 1Vpp
- Balanced line input = -11dBm
- Unbalanced line input = 1Vpp

There is a small amount of attenuation applied to the talk through audio with in the T1810 CM. The balanced line input has a *nominal* value of '-11dBm', however this can vary between '-11dBm' and '-11.5dBm' depending on the reciter frequency band, and the bandwidth selected

The talk-through audio should be *checked* as follows

1. Set SW200 to '8' and SW201 to '3', press SW202 to reset.
2. Connect a signal generator to the base station receiver, set to the frequency of operation.
3. Attach the output of the PA to modulation meter or similar measuring device. (*via suitable attenuator if necessary*)
4. Modulate a 1kHz test tone onto the carrier of the signal generator at a deviation equal to 60% of the maximum permissible deviation (1.5kHz for 12.5kHz channel spacing and 3.0kHz for 25kHz channel spacing systems).
5. Set the signal level to represent a fully quieting strong signal (e.g. -80dBm).
6. With the Signal path configured as shown for a T1810 CM the deviation measured should be ~ 60% of system max. If this is incorrect check the calibration of the SIF card.

Slight adjustment of the TB8100 balanced line input may be required for a more exact 60% of max deviation, however large changes may indicate a SIF calibration issue, the values suggested were tested on both old and new revisions of T1810 CM hardware

The Rx FFSK input signal should be adjusted as follows

1. Set SW200 to '8' and SW201 to '1', press SW202 to reset.
2. Link PL200 **1 – 2**, Rx FFSK signal is flat
3. Connect a signal generator to the base station receiver, set to the frequency of operation.
4. Set the signal level to represent a fully quieting strong signal (e.g. -80dBm).
5. Modulate the carrier with a 1500Hz tone at a deviation equal to 60% of the maximum permissible deviation (1.5kHz for 12.5kHz channel spacing and 3.0kHz for 25kHz channel spacing systems).
6. Now adjust RV201 to obtain a 234mVrms (0.66 V peak-to-peak) signal at test point P201.

The Tx FFSK output signal should be adjusted as follows

1. Set SW200 to '8' and SW201 to '2', press SW202 to reset.
2. Set PL202 to **1 – 2**, Tx FFSK signal is flat
3. Attach the output of the PA to modulation meter or similar measuring device. (*via suitable attenuator if necessary*)
4. With the T1810 CM card running as a control channel transmitting FFSK, adjust RV200 until 60% of max system deviation is achieved on the modulation meter.

Issuing Authority

**Name and Position
of Issuing Officer**

Paul Hinton
Technical Support Engineer

Confidentiality

Confidential – This message or document contains proprietary information intended only for the person(s) or organisation(s) to whom it is addressed. All Recipients are legally obliged to not disclose Tait technological or business information to any persons or organisations without the written permission of Tait.

Distribution Level

Associate

Document History

Original Release	31 July 2003	D Whitlock
Update	21 February 2005	P Hinton
Update	28 June 2005	S McQueen
Update + T1511 added	1 September 2005	P Hinton
Update Ethernet SIF added, general updates.	23 May 2006	J Northcott